



premier
pack

CATÁLOGO

HOME & SPA





ARIEL

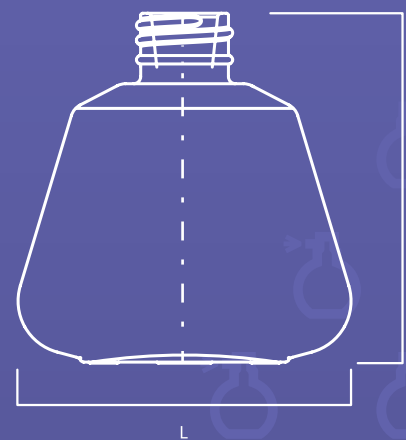

REFERÊNCIA ARIEL

CAPACIDADE (ml) 250ml

TERMINAÇÃO 28/410

PESO (g) 275

ALTURA A (mm) 99,3

CORPO Ø (mm) 94,5

QTD. MÍNIMA (peças) 1.000



CILÍNDRICO

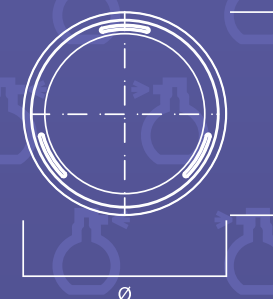
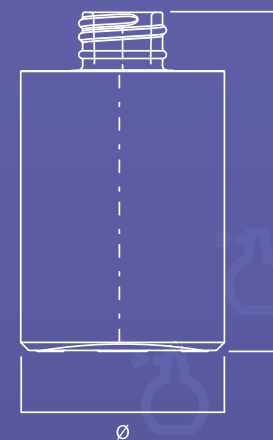

REFERÊNCIA	3.010.113223
CAPACIDADE (ml)	130
TERMINAÇÃO	28/410
PESO (g)	222
ALTURA (mm)	97,2
CORPO Ø (mm)	60
QTD. MÍNIMA (peças)	1.000



DARYA

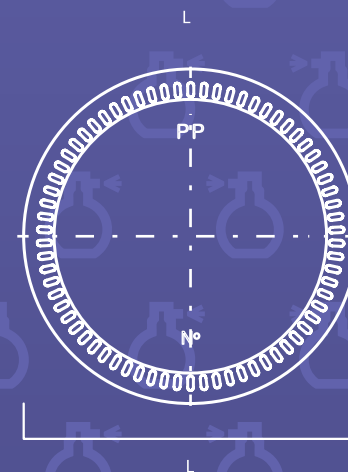
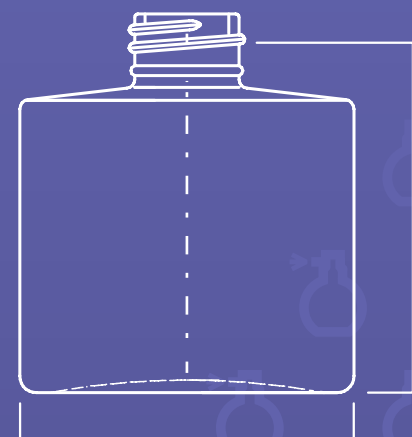

REFERÊNCIA	DARYA
CAPACIDADE (ml)	200ml
TERMINAÇÃO	28/410
PESO (g)	345
ALTURA A (mm)	90
CORPO Ø (mm)	79,6
QTD. MÍNIMA (peças)	1.000



DICE ALTUS

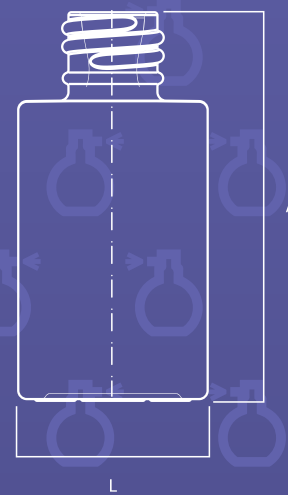
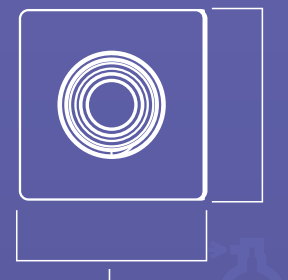

REFERÊNCIA 3.002.0012

CAPACIDADE (ml) 30 ml

TERMINAÇÃO 18/415

PESO (g) 55

ALTURA A (mm) 67,7

CORPO L x l (mm) 33 x 33

QTD. MÍNIMA (peças) 1.000



DICE

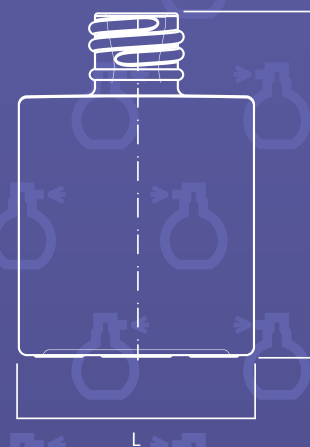
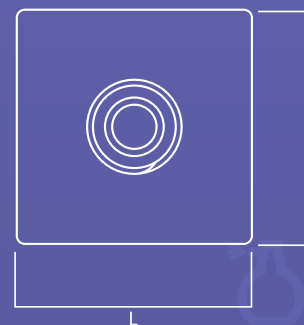

REFERÊNCIA	3.002.2597	3.002.2598	3.002.2600	3.002.1385
CAPACIDADE (ml)	30	50	100	250
TERMINAÇÃO	18/415	18/415	28/410	28/410
PESO (g)	70	105	205	339
ALTURA A (mm)	53	65	80	102
CORPO L x l (mm)	40 x 40	44 x 44	55 x 55	72 x 72
QTD. MÍNIMA (peças)	10.000	1.000	1.000	1.000



DUBLIN

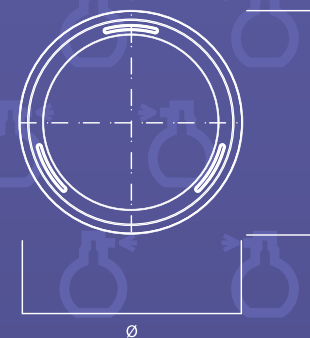
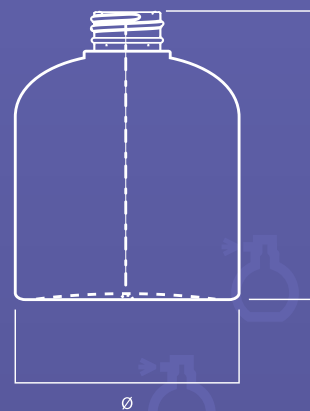

REFERÊNCIA	DUBLIN 100	3.010.1113104
CAPACIDADE (ml)	100	200
TERMINAÇÃO	28/410	28/410
PESO (g)	180	306
ALTURA A (mm)	90.8	118
CORPO Ø (mm)	59	73
QTD. MÍNIMA (peças)	10.000	1.000



FLEX

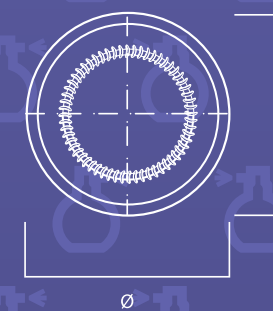
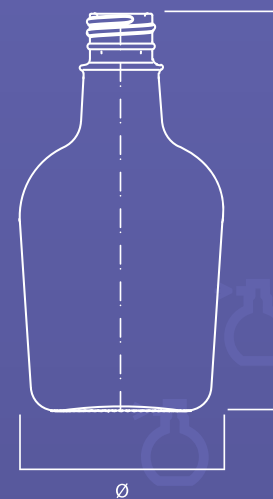

REFERÊNCIA	2.00.H3096
CAPACIDADE (ml)	350
TERMINAÇÃO	28/410
PESO (g)	280
ALTURA A (mm)	158,5
CORPO Ø (mm)	81
QTD. MÍNIMA (peças)	10.000



LISBOA

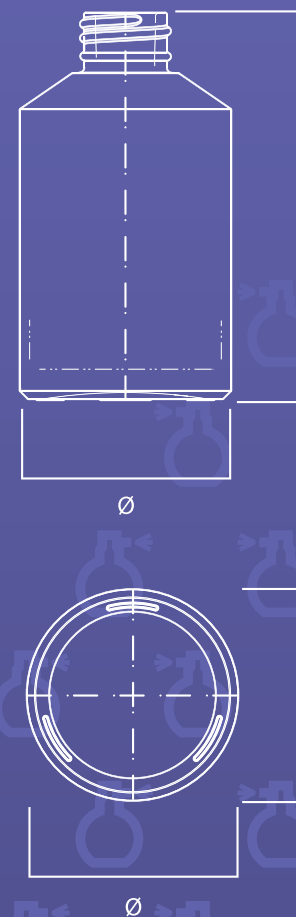

REFERÊNCIA 3.101.03T1524

CAPACIDADE (ml) 200 ml

TERMINAÇÃO 28/410

PESO (g) 220

ALTURA A (mm) 116,3

CORPO Ø (mm) 63,5

QTD. MÍNIMA (peças) 1.000



QUADRADO

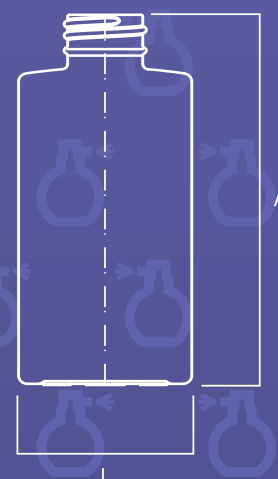
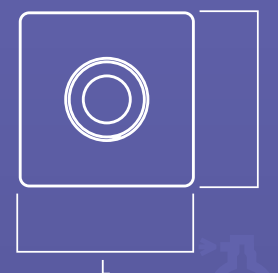

REFERÊNCIA	3.010.11143353	3.010.11122277
CAPACIDADE (ml)	110	250
TERMINAÇÃO	20/415	28/410
PESO (g)	155	285
ALTURA A (mm)	133,3	138
CORPO L x l (mm)	40 x 40	57 x 57
QTD. MÍNIMA (peças)	10.000	1.000



TEXAS

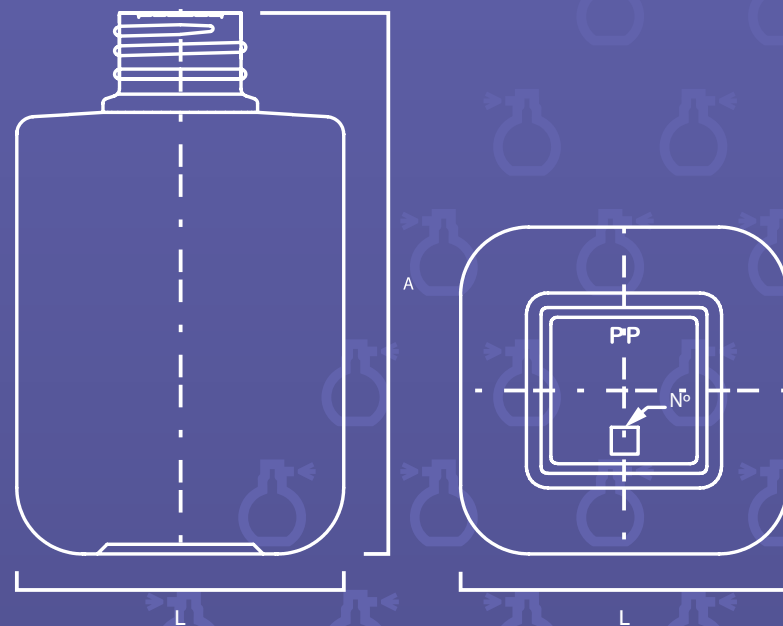

REFERÊNCIA	T4141
CAPACIDADE (ml)	250
TERMINAÇÃO	GPI
PESO (g)	300
ALTURA A (mm)	110,8
CORPO L x l (mm)	67 x 67
QTD. MÍNIMA (peças)	1.000



CLASSIC CIRCULAR

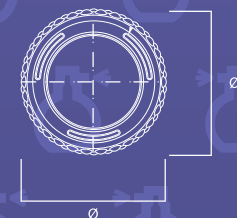
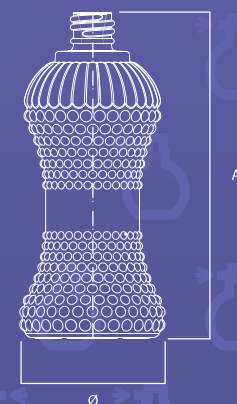
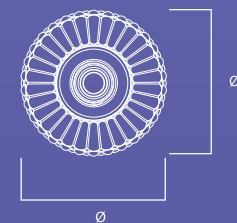

REFERÊNCIA	3.002.4694	3.002.4639
CAPACIDADE (ml)	100	220
TERMINAÇÃO	18/415	28/410
PESO (g)	186	299
ALTURA A (mm)	130	160
CORPO Ø (mm)	58	68
QTD. MÍNIMA (peças)	1.000	1.000



DIFUSOR X

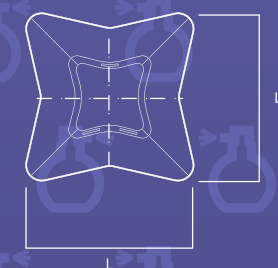
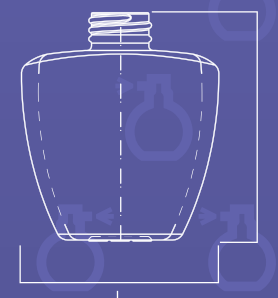
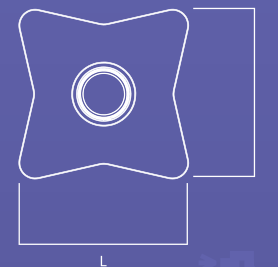

REFERÊNCIA	3.002.2863
CAPACIDADE (ml)	250
TERMINAÇÃO	28/410
PESO (g)	300
ALTURA A (mm)	82
CORPO L x l (mm)	100 x 100
QTD. MÍNIMA (peças)	1.000



LICOR

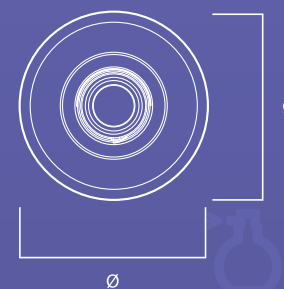

REFERÊNCIA 3.101.03T1644

CAPACIDADE (ml) 200

TERMINAÇÃO 28/410

PESO (g) 250

ALTURA A (mm) 127

CORPO Ø (mm) 70

QTD. MÍNIMA (peças) 10.000



MOSAICO

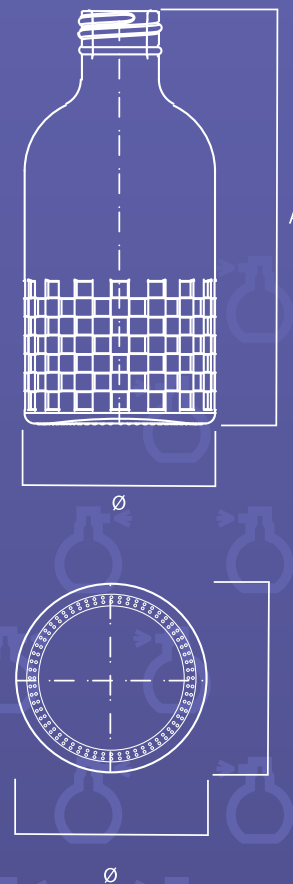

REFERÊNCIA	3.001.7373
CAPACIDADE (ml)	200
TERMINAÇÃO	28/410
PESO (g)	255
ALTURA A (mm)	137,3
CORPO Ø (mm)	63
QTD. MÍNIMA (peças)	10.000



PÉTALA

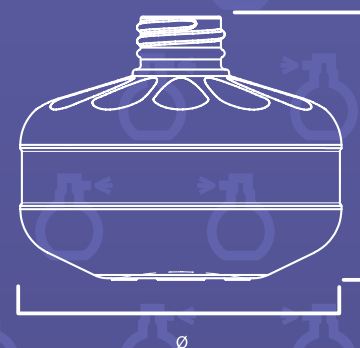
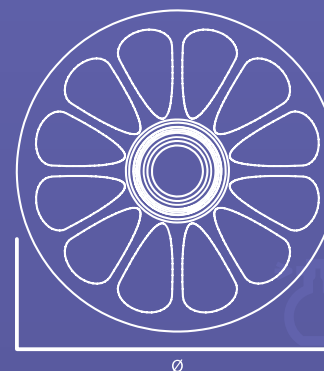

REFERÊNCIA	PP-017
CAPACIDADE (ml)	280
TERMINAÇÃO	28/410
PESO (g)	300
ALTURA A (mm)	82
CORPO ∅ (mm)	100
QTD. MÍNIMA (peças)	10.000



PIRÂMIDE

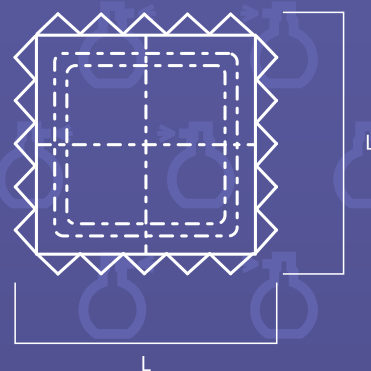
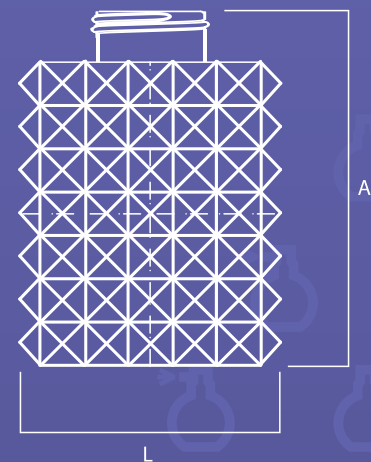

REFERÊNCIA 3.002.4249

CAPACIDADE (ml) 100

TERMINAÇÃO 28/410

PESO (g) 232

ALTURA A (mm) 90

CORPO L x l (mm) 54 x 54

QTD. MÍNIMA (peças) 1.000



VELA 156

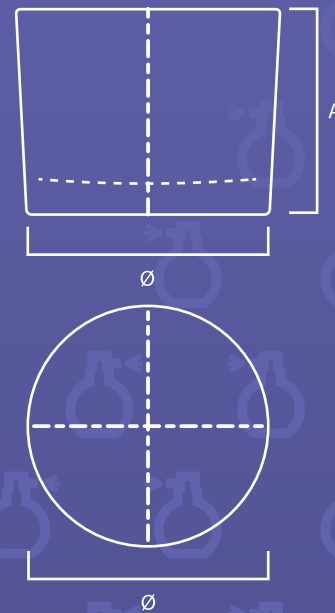

REFERÊNCIA	VELA 156
CAPACIDADE (ml)	156
PESO (g)	110
ALTURA (A) (mm)	52,2
CORPO (Ø) (mm)	73,4
QTD. MÍNIMA (peças)	1.000



POTE SPA

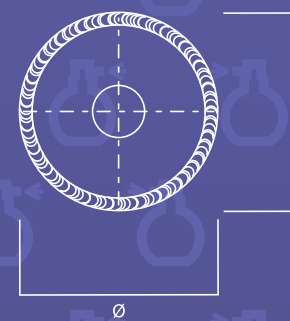
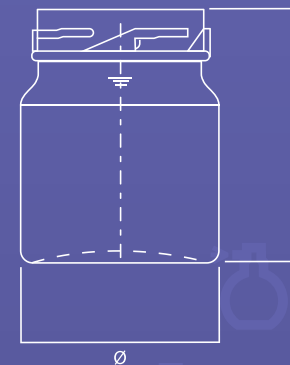

REFERÊNCIA	STD 156	STD 250	STD 410
CAPACIDADE (ml)	120	210	360
CAPACIDADE TOTAL (mm)	156	250	410
TERMINAÇÃO (mm)	58	70	70
PESO (g)	120	165	261
ALTURA (mm)	77	84	113,4
CORPO Ø (mm)	60,2	72,5	78,6
QTD. MÍNIMA (peças)	1.000	1.000	1.000



AUSTRAL

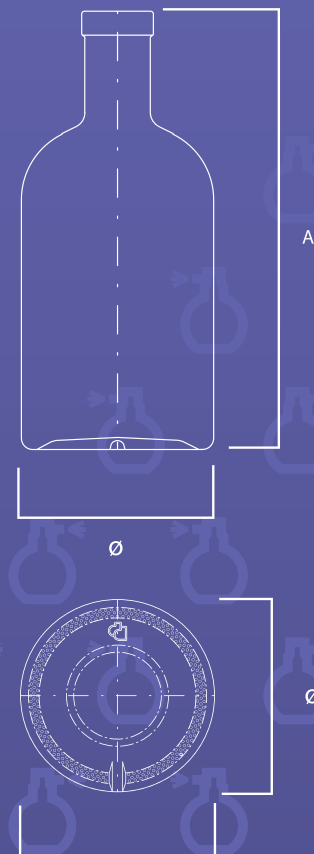

REFERÊNCIA	AUSTRAL	AUSTRAL	AUSTRAL	AUSTRAL
CAPACIDADE	200	375	700	750
TERMINAÇÃO	ROLHA	ROLHA	ROLHA	ROLHA
PESO (g)	300	420	680	680
ALTURA (mm)	147,6	177,4	215	220
CORPO Ø (mm)	64	74,8	91,5	92,3
QTD. MÍNIMA	100	100	100	100



BOTÂNICA



REFERÊNCIA BOTÂNICA

CAPACIDADE (ml) 700

TERMINAÇÃO ROLHA

PESO (g) 580

ALTURA A (mm) 175.5

CORPO Ø (mm) 94.5

QTD. MÍNIMA (peças) 100



BUBBLE

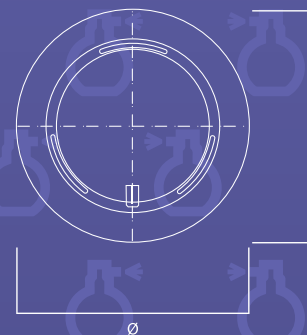
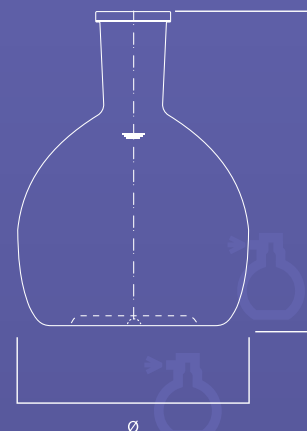

REFERÊNCIA 2.001.6123

CAPACIDADE (ml) 700

TERMINAÇÃO ROLHA

PESO (g) 855

ALTURA (mm) 169

CORPO Ø (mm) 125

QTD. MÍNIMA (peças) 100



CARIBE



REFERÊNCIA CARIBE

CAPACIDADE (ml) 700

TERMINAÇÃO ROLHA

PESO (g) 550

ALTURA (mm) 194,4

CORPO L X l (mm) 105 X 85

QTD. MÍNIMA (peças) 100



ISLA

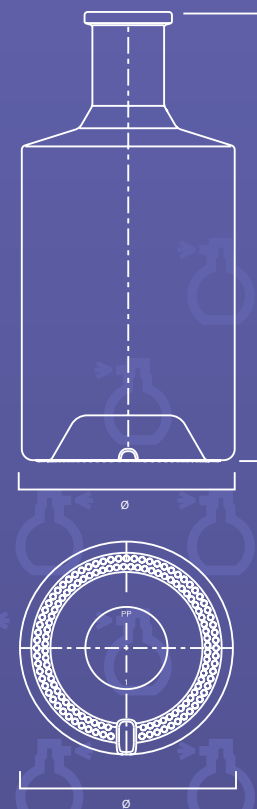

REFERÊNCIA	ISLA
CAPACIDADE (ml)	750
TERMINAÇÃO	ROLHA
PESO (g)	550
ALTURA (mm)	200,5
CORPO L X l (mm)	95
QTD. MÍNIMA (peças)	100



LITTLE SUMMO

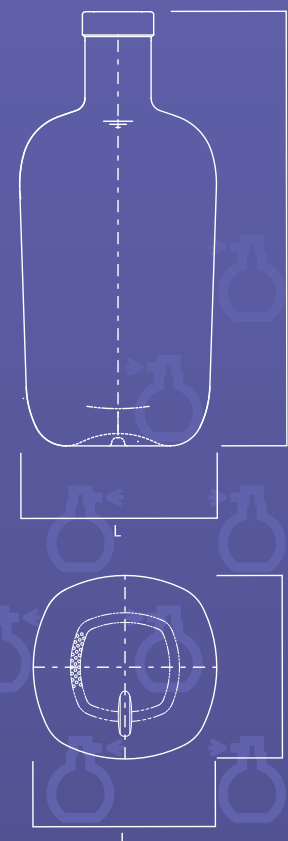

REFERÊNCIA	3.001.5152	3.001.5810	3.001.5810
CAPACIDADE (ml)	350	500	700
TERMINAÇÃO	Rolha	Rolha	33/400
PESO (g)	530	643	905
ALTURA (mm)	169,5	188	211
CORPO L x l (mm)	77,2 x 77,2	91,9 x 91,9	95,2 x 95,2
QTD. MÍNIMA (pça)	1.800	1.430	100



MIXOLOGIST

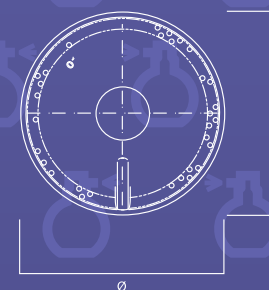
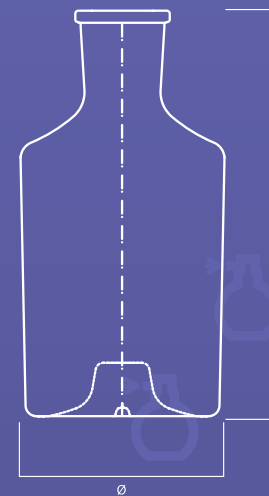

REFERÊNCIA	2.001.6025	2.001.5594
CAPACIDADE (ml)	375	700
TERMINAÇÃO	ROLHA	ROLHA
PESO (g)	315	500
ALTURA (mm)	157,7	190
CORPO Ø (mm)	78,2	95
QTD. MÍNIMA (peças)	100	100



NEOS

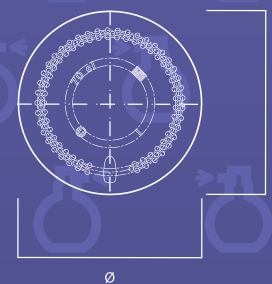
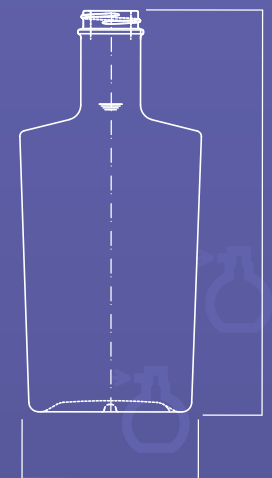

REFERÊNCIA	3.001.3888	2.001.3557
CAPACIDADE (ml)	350	700
TERMINAÇÃO	28/400	Rolha
PESO (g)	440	810
ALTURA (mm)	175,4	213
CORPO Ø (mm)	78,1	97,2
QTD. MÍNIMA (peças)	1 palete	100



OTSO

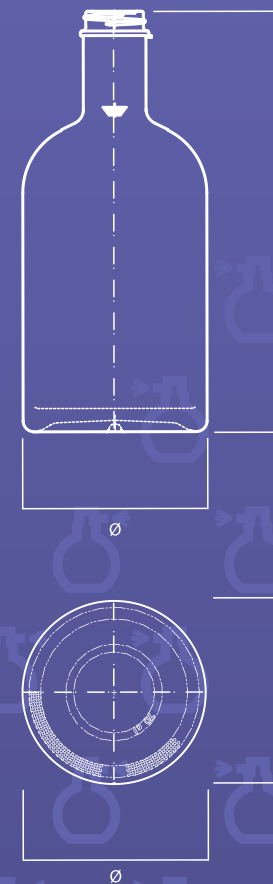

REFERÊNCIA	3.001.3019	3.001.3168	2.001.2844
CAPACIDADE (ml)	200	350	500
TERMINAÇÃO	28/400	28/400	28/400
PESO (g)	282	429	588
ALTURA (mm)	149,4	177,4	194
CORPO Ø (mm)	63	74,8	84,3
QTD. MÍNIMA (peças)	100	100	100



QBIC

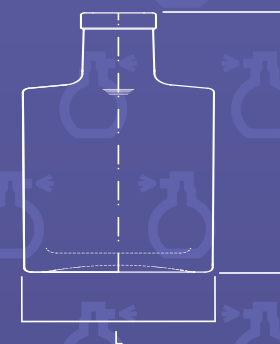
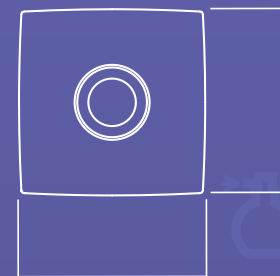

REFERÊNCIA	3.001.5173	3.001.3926
CAPACIDADE (ml)	350	500
TERMINAÇÃO	ROLHA	ROLHA
PESO (g)	630	830
ALTURA (mm)	147,8	160,7
CORPO L x l (mm)	78,1 x 78,1	87,8 x 87,8
QTD. MÍNIMA (peças)	1.440	100



QUARTZO

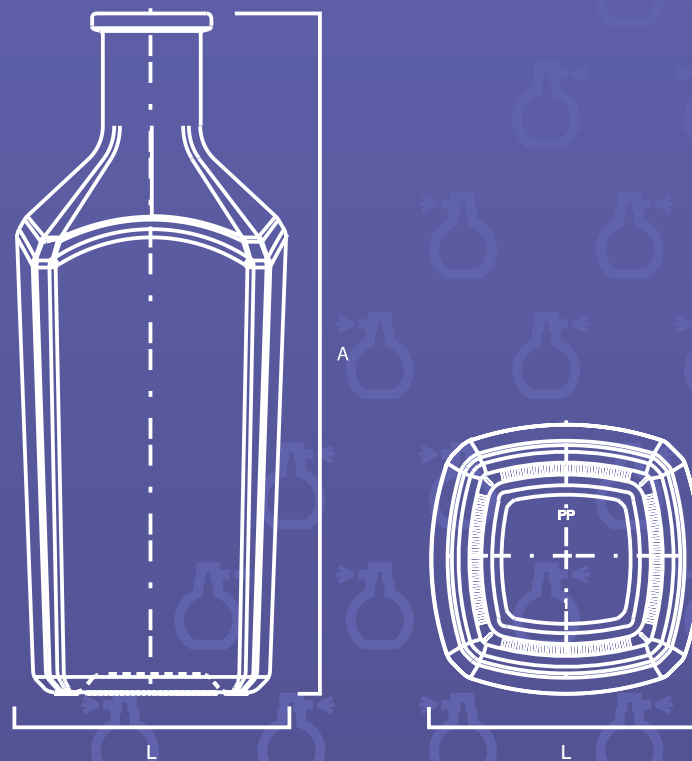

REFERÊNCIA	2108
CAPACIDADE (ml)	700
TERMINAÇÃO	PLATE
PESO (g)	720
ALTURA (mm)	222,3
CORPO L x l (mm)	87,5
QTD. MÍNIMA (peças)	100



TEXAS

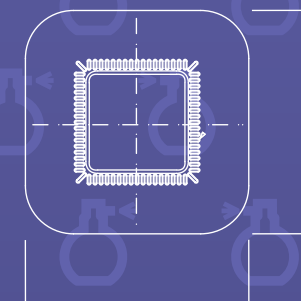
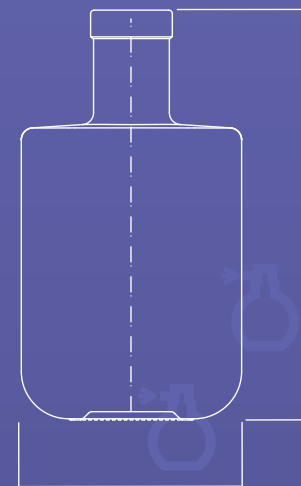

REFERÊNCIA	2.102.860020
CAPACIDADE (ml)	700
TERMINAÇÃO	ROLHA
PESO (g)	750
ALTURA (mm)	173
CORPO L x l (mm)	93 x 93
QTD. MÍNIMA (peças)	100



UNIDADE 1: Rua Florianópolis, 123 - Fazendinha
Santana de Parnaíba - SP | CEP: 06529-302
Tel: (+55 11) 4705-9610

UNIDADE 2: Av. Arnaldo Contursi, 2030
Marta Helena - Uberlândia - MG | CEP: 38402-284
Tel: (+55 34) 3222-6084

UNIDADE 3: Av. Joaquim Ribeiro, 132 - Galpão B
Caxangá - Recife - PE | CEP: 50980-000
Tel: (+55 81) 3272-9519

WWW.PREMIERPACK.COM.BR

